

i Charger Synchronous Balance Charger/Discharger

208B



User's Manual



Index

Specifications	3
Special Features	3
Unpack Inspection	5
External Controls and Connections	5
Warnings and Safety Notes	6
Program Flow Chart	7
Keyboard Basics	8
Parameter Setup	9
Lithium Battery Program	12
Charging Lithium Battery in BALANCE Mode	13
Charging a Lithium Battery in Normal CHARGE Mode	14
Fast Charging a Lithium Battery	14
Pre-charging a Lithium Battery	15
“Storage” charge/discharge a Lithium Battery	15
Discharging a Lithium Battery.....	16
Lithium Battery External Expanding Discharge Mode	17
Cycle Mode for a Lithium Battery	18
Lithium Battery in Monitoring Mode	18
NiCd/NiMH Battery Program	19
Charging a NiCd/NiHM Battery	19
Discharging a NiCd/NiMH Battery	19
Cycle Mode for a NiCd/NiMH Battery	19
NiCd/NiMH Forming Charge	20
Pb (lead-acid) Battery Program	21
Charging a Pb Battery	21
Discharging a Pb Battery	21
Special Modes Program	22
Electric Motor Drive	22
Foam-Cut Drive	22
Measuring Internal Resistance of the Battery.....	23
Data Save/Load Program	24
Log Files Management.....	25
General Status Information	26
Warning and Error Information	26
USB port installation	28
Install USB Driver	28
Charger firmware upgrade steps	28
Using LogView for 208B	29
Optional Parts.....	31
Limited Warranty.....	32



Thank you for purchasing one of the **iCharger** series. Please read the entire User's Manual completely and attentively as it contains a wide variety of specific programming and safety information.

Specifications

Input voltage range:	4.5 – 32.0VDC
Charge current range:	0.05 – 20.0A
Discharge current range:	0.05 – 20.0A
Maximum charge power capacity:	350W @ input voltage > 18V
Maximum discharge power capacity:	30W
Maximum extern discharge power capacity:	600W @ 30V/20A
Current drain for balancing:	<350mA
Balance accuracy:	<10mV
Lithium (LiPo/LiLo/LiFe) battery cell count:	1 – 8 series (In non-balance mode, expand LiFe to 10s)
NiCd/NiMH battery cell count:	1 – 25 series
Pb battery cell count:	1 – 18 series (2 –36V)
Log Files storage:	16Mbit (36 hours)
Battery setup memories:	10
Intelligent temperature control:	Yes
PC Connect:	USB port
Weight:	420g
Dimensions (L X W X D):	143X97X26mm 5.63”X3.82”X1.02”

Special features

- High power, high current, high-performance power conversion circuit. The **iCharger** series uses advanced **Synchronous buck-boost DC/DC converter** technology with an output conversion efficiency that can reach over 90%. This not only saves power and reduces heat build up but also makes the charger more compact and conveniently mobile.
- Input power with 4mm bullet connectors (25A) butt-welded alligator clips and wide input voltage ranges from 4.5V to 32V. The output power can be adjusted to align with the available input power, thus preventing input current overload and protecting the DC source.
- The **iCharger** series can be used with three types of Lithium batteries - LiPo, LiLo, LiFe - and has a fully integrated cell balancer.
- Internal temperature sensor and temperature controlled automatic cooling FAN controls the internal temperature and provides intelligent protection. When the internal temperature is over 60°C(140 °F), the output power is automatically reduced by 25%. If the temperature exceeds 65°C(149 °F) the charge cycle is stopped.
- Convenient set of 10 battery profile memories that can be saved and loaded by number.
- 2x16 backlit LCD screen that provides rich information including active mode, current, voltage, total charge (mAh), charging time and temperature etc.
- Various charging/discharging settings and cycles to meet a wide range of customer needs. For Lithium batteries: balance charging, normal charging, fast charging, storage, discharging, ext-discharging, charge/discharge cycling, and battery monitoring. For NiCd/NiMH batteries: charging-auto, charging-manual, discharging, charge/discharge cycling and forming charge. For Pb batteries: charging and discharging.
- Unique Lithium battery expanding discharge program. When you connect the external capacity resistance, you can use it as the maximum discharge power capacity—600W (@30V/20A).
- Unique Lithium battery Monitor program. When you use other equipment to charge or discharge a Lithium pack, you can use the **iCharger** to monitor the per-cell voltages, battery temperature and process time. If any individual cell appears over-charged or over-discharged or the pack is too hot or the process has gone on for too long, the **iCharger** will generate an alarm sound and the related information will blink.
- Electric motor test mode can be used to run-in electric motors, test motor parameters and performance, check tolerances etc.



- Foam-cut drive. In this mode, the charger acts as a convenient power supply for a hot wire foam cutter.
- Battery interior resistance measurement. The **iCharger** can not only measure the internal resistance of the battery pack, and also can measure the per-cell internal resistance (only available for lithium battery).
- Perfect protection. The **iCharger** has protection for reversed polarity (input or output), low input voltage, battery temperature, charging capacity and time overrun.
- **iCharger** 208B has a 16Mbit flash storage, which can log offline charge and discharge data in 36 hours.
- Support upgrading the hardware program by USB port. The **iCharger** also support the “logview” software and can display, plot and analyze the charge and discharge data by it. (See detail information about **logview** in the following website: <http://www.logview.info>)



Unpack inspection

The following items are included in the package. Contact your supplier if any items are missing.

Standard items:

- One copy of the User's manual on CD
- One pair of output alligator clip leads
- One pair of input alligator clips (30A) and input leads with 4mm bullet connectors
- One temperature sensor lead (0 – 99°C(210 °F))
- Four rubber feet
- One exclusive Mini-USB data line(1.2 meter)

Optional items:

See details in “Optional parts” (P31)

External controls and connections

208B



1. DC input 2. LCD screen 3. Function button 4. Cooling Fan 5. Temperature sensor port
 6. Balance socket 7. Output port 8. USB port

**Warnings and Safety notes**

- Keep the charger away from children and pets at all times.
- Never leave the charger unsupervised when charging or discharging. If you leave, disconnect the battery to prevent any unexpected dangers or damage.
- Ensure the charger program and settings match the battery pack otherwise the battery will be damaged and a dangerous situation may arise, especially for Lithium batteries, which may cause a fire.
- Do not mix batteries of different types, different capacities or from different manufacturers.
- Do not disassemble the charger.
- Do not place the charger or any battery on a flammable surface or near a combustible material while in use. Do not charge or discharge on a carpet, cluttered workbench, paper, plastic, vinyl, leather or wood, inside an R/C model or inside a full-sized automobile.
- Never block the air intake holes and never use in a refrigerated or high temperature environment. If used in such an environment, the internal temperature protection may result in abnormal charging/discharging that could be dangerous.
- Do not allow water, moisture, metal wires or other conductive material into the charger.
- Never charge or discharge any battery having evidence of leaking, expansion/swelling, damaged outer cover or case, color-change or distortion.
- Do not try to charge “non-rechargeable” dry cells.
- Do not exceed the battery manufacturer’s suggested maximum charge rates.
- Beware that the external case temperature of the charger will increase during charging/discharging at high power.
- Carefully follow the battery pack manufacturer’s recommendations and safety advice.

Recommended connecting way:

1. Connect **iCharger's** input power supply, and turn on it.
2. Connect Li batteries' balance port
3. Connect the main charging port's positive pole to cells' positive pole, and then connect negative pole to cells' negative pole (this will avoid striking fire while connecting Li cells).
4. Start charging and discharging...
5. After finishing charging and discharging, pls disconnect the cell and charger, and then turn off the charger's power supply.

Standard battery parameters

	LiPo	Lilo	LiFe	NiCd	NiMH	Pb
Nominal voltage	3.7 V/cell	3.6 V/cell	3.3 V/cell	1.20 V/cell	1.20 V/cell	2.0 V/cell
Max. charge voltage	4.2 V/cell	4.1 V/cell	3.6 V/cell	1.60 V/cell	1.60 V/cell	2.45 V/cell
Storage voltage	3.85 V/cell	3.75 V/cell	3.3 V/cell	n/a	n/a	n/a
Allowable fast charge	≤ 1C	≤ 1C	≤ 4C	1C – 2C	1C – 2C	≤ 0.4C
Min. discharge voltage cut-off level	≥ 3.0 V/cell	≥ 2.5 V/cell	≥ 2.0 V/cell	≥ 0.85V/cell	≥ 1.0 V/cell	≥ 1.75V/cell

Note: Be very careful to choose the correct voltage for different types of battery otherwise you may cause damage to the batteries. Incorrect settings could cause the cells to vent, burn or explode leading to injury or loss of property.



Program flow chart

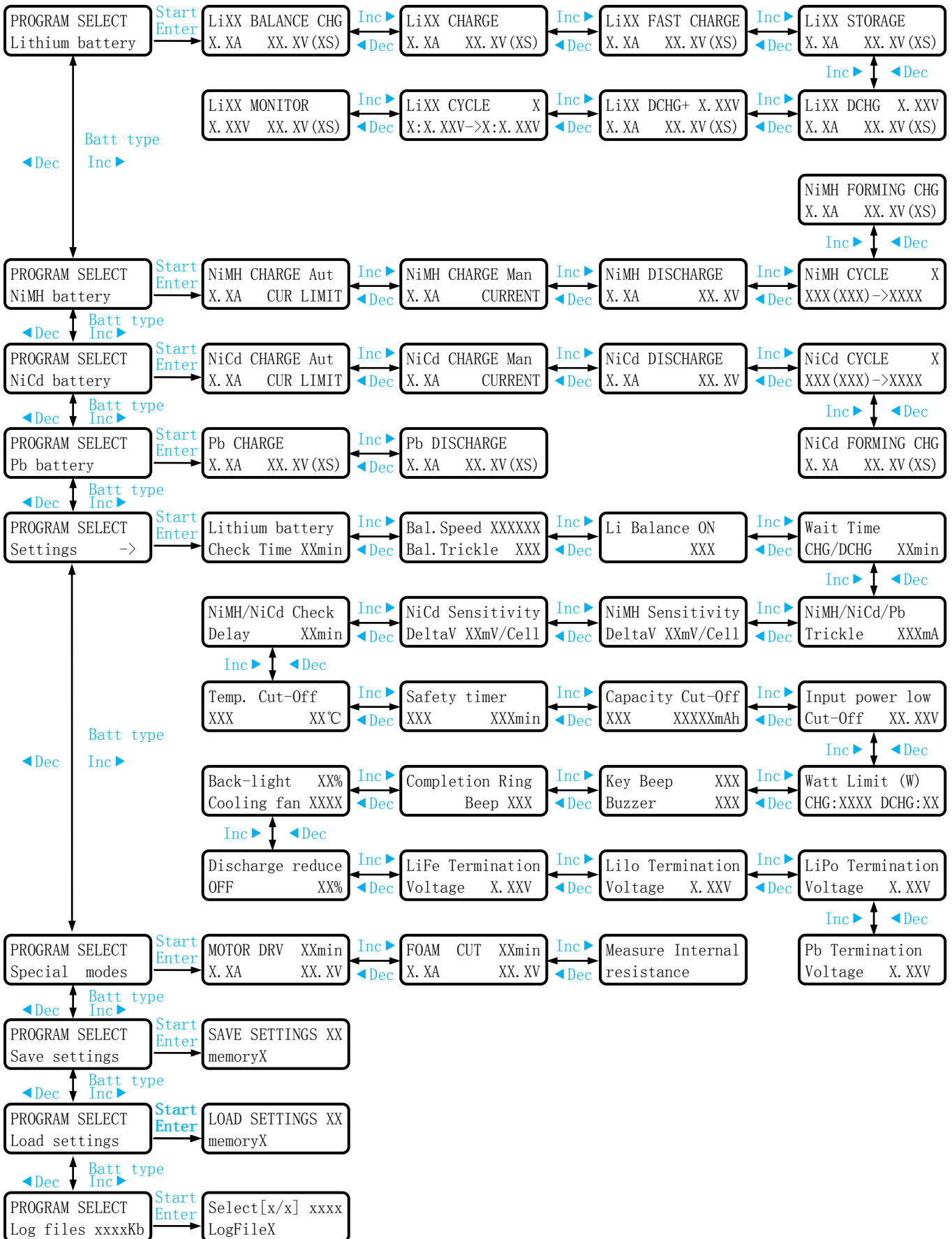

Note: When you turn off the iCharger it will remember the current menu and start from that menu when next turned on again.



Keyboard basics

1. Go to the main menu, press the **Inc▶** button or the **Stop/Batt type** button to go down, and press the **◀Dec** button to go up: press the **Start/Enter** button to enter a sub-menu.
2. In a sub-menu, press **Start/Enter** to blink the chosen item, and then alter the value with **Inc▶** or **◀Dec**. With nothing blinking you can go to the sub-menu below with **Inc▶** and above with **◀Dec**. Press **Stop/Batt type** to go back to the previous screen.
3. In some sub-menus, press and hold **Start/Enter** for more than 3 seconds to start the process, such as starting charging or discharging.
4. During the charging/discharging process you can terminate the process at any time by pressing **Stop/Batt type** and check the attached information with **Inc▶** or **◀Dec**. Press **Start/Enter** to go back to the main information screen.
5. During the discharge process, press **Start/Enter** to alter the discharge current. When the discharge current blinks, press **Inc▶** to increase it or **◀Dec** to decrease it, then press **Start/Enter** to confirm the change.
6. Press **Stop/Batt type** for more than 3 seconds to start the display of the active test information as per the following diagram.

Present testing information:

In this display the output voltage is the idle voltage measured at the output terminals (that is, the voltage of the connected battery pack).

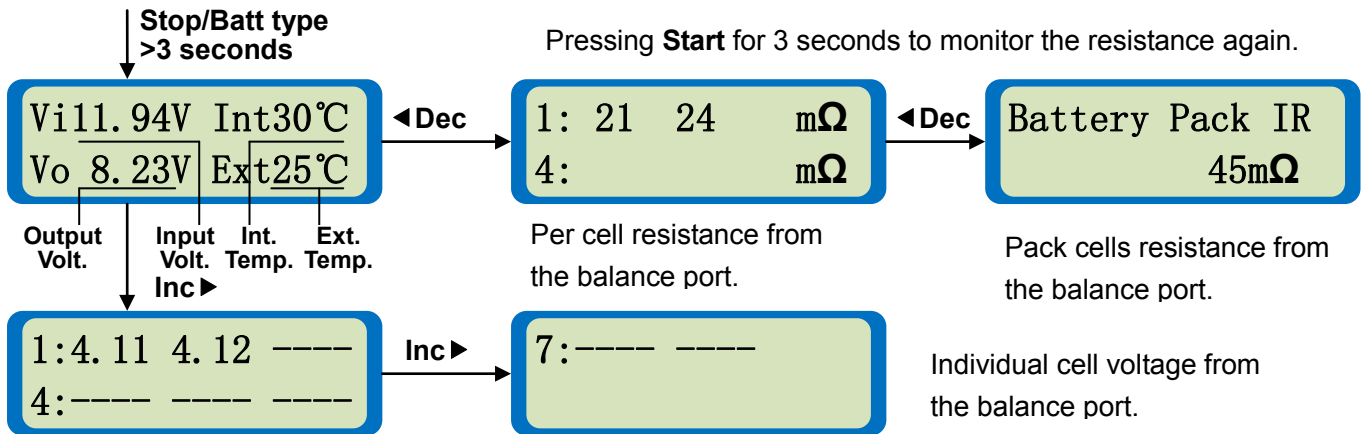

7. **Reset to Defaults** function. Press **Stop/Batt type** and **Start/Enter** together for more than 3 seconds to obtain this display:

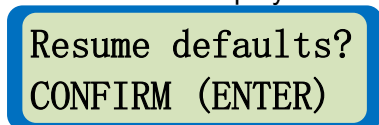

Press **Start/Enter** to reset all values to the system-default settings.

8. Adjust Current, Temp. Cut-Off, Safety timer, Capacity Cut-Off in course of charging and discharging.

Method of Application:

When in charging and discharging interface, press **Start/Enter** for 3 seconds, and current begins blinking.

Press **Inc▶** or **◀Dec** to adjust current, and press **Start/Enter** to save changes. If users press **Stop/Batt type** or without any operation for 1 minute, it will cancel and quit from the changes.

Note: Adjustment of current is only effective for charging and discharging, which will not saved as user setting.

When in charging and discharging interface, press **◀Dec** for several times to see need-to-be changed information interface. Press **Start/Enter** for 3 seconds, and the value begins blinking. The adjust method is as same as the above.

Note: This change can be saved as user setting.



Parameter setup

Users should check the parameter settings and adjust the parameter values according to the specifications of the pack to be charged or discharged.

Note: The screen diagram on the left shows the system's default setting.

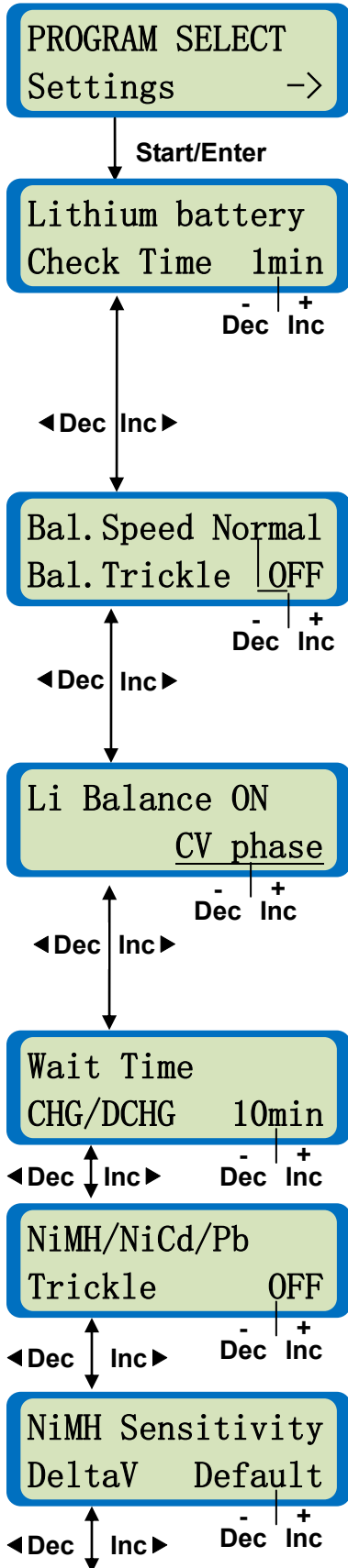

User parameter setup initial display.

iCharger checks the cell count of Lithium batteries automatically at the beginning of the charge or discharge process in order to detect and avoid erroneous setting by the user. However, deeply discharged batteries can be perceived incorrectly. To avoid this problem you can set an initial time during which to charge the battery at a low current, usually 100mA. Normally 10 minutes is enough to detect the cell count correctly. For batteries of different capacities, you should adjust the time delay. Note: If you set the time delay too long for a low capacity battery then the charging process can be finished within the time delay with an erroneous cell count, which may damage the battery and could be dangerous.

Range: 1 – 10 min. (1min, default)

For balance charging Lithium batteries. If the Bal. Speed is set to Fast, the CV termination current will be higher, the charging time shorter and the per-cell voltage lower. When set to Slow, the CV termination current will be lower, the charging time longer and the per-cell voltage higher. The default value of Normal is between the Fast and the Slow. If Bal. Trickle is ON, the iCharger won't stop charging until the current falls to around 20mA.

Bal.Speed: Fast, Normal & Slow, (Normal, default).

Bal.Trickle: OFF & ON: (OFF, default)

For balance charging Li battery. There are three balance modes options: CV phase, storage voltage and always. If the balance mode is set to CV phase, when any cell's voltage reaches the set voltage for CV, it will enable the balancer. When set to "always", the balancer will be enabled from the beginning of the charge process. When set to "storage voltage", the balancer will be enabled when any cell's voltage exceeds the default storage voltage for the configured chemistry.

Balance mode: CV phase, storage voltage, always (CV phase, default)

When running a charge/discharge cycle program for a Lithium, NiMH or NiCd battery the charger will stop for a while before continuing to the next phase. This allows the pack to cool down.

Range: 1 – 60 min. (10 min default)

You can turn post charge-completion trickle charging. On or Off for NiMH, NiCd or Pb batteries.

Range: OFF, 10 – 500mA. (OFF,default)

Usually, the NiMH battery voltage will drop a little right after reaching full charge. This is known as -ΔV. You can alter the iCharger's delta-peak detection sensitivity.

Range: 1 – 20mV/Cell. (4mV/Cell, default)

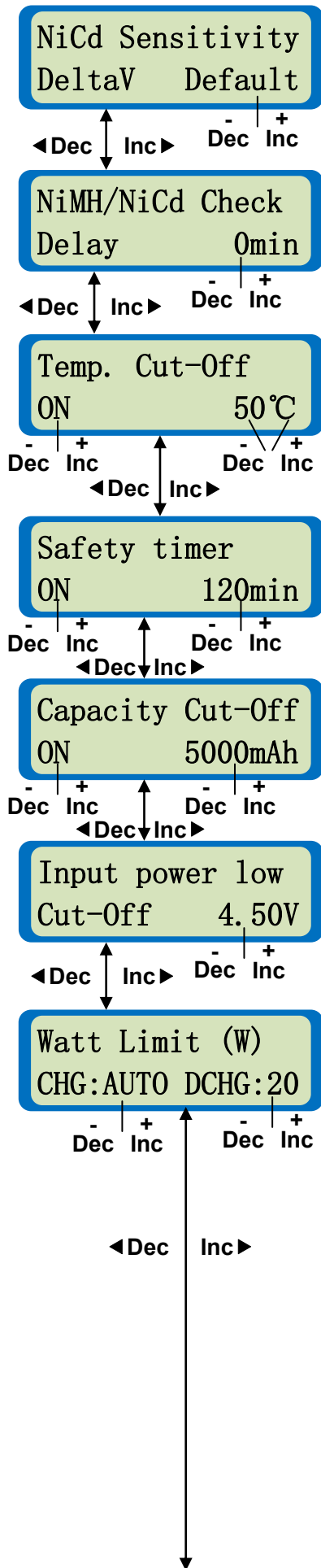

Usually, the NiCd battery voltage will drop a little right after reaching full charge. This is known as $-\Delta V$. You can alter the **iCharger's** delta-peak detection sensitivity.
 Range: 1 – 20mV/Cell. (8mV/Cell, default)

When NiMH&NiCd batteries are deeply discharged or left unused for a long time, they will produce a false $-\Delta V$ which stops charging early. You can disable $-\Delta V$ testing to avoid this problem.
 Range: 0 – 30min (0, default)

Battery upper temperature limit. The battery temperature can be monitored with the attached temperature sensor. In order to protect the battery from damage due to high temperatures the **iCharger** will stop charging or discharging immediately if the temperature exceeds the cut-off setting. Users can choose °C or °F as the temperature unit
 Range: 20 – 80°C(68 – 176 °F). °F = (9/5)×°C+32.

Charging time upper limit. The charging process will stop immediately if it exceeds the set value.
 Range: 1 – 999min

Capacity protection. The charging/discharging process will stop immediately if the calculated charge input/drained exceeds the set value.
 Range: 100 – 99900mAh

Input voltage protection lower limit. The charging/discharging process will stop immediately if the input voltage falls below the set value.
 Range: 4.50 – 30.00V (4.50V, default)

Charge/Discharge power limit. The maximum charge/discharge power of **iCharger** can be adjusted in order to limit internal temperature and to **protect the input current from over-loading**. When the limit is set to AUTO the **iCharger** can adjust the output charging power according to the input capability.
 CHG: 50 –350W and AUTO. DCHG: 5 –30W

Note: The maximum charge power capacity is also limited by input current. The maximum input current of 208B is about 24A, and $W_{max} \approx I_{max} * V_{in} * 90\%$. (For example, when the input voltage is 11V, the maximum charge power capacity $\approx 24 \times 11 \times 90\% = 238W$).

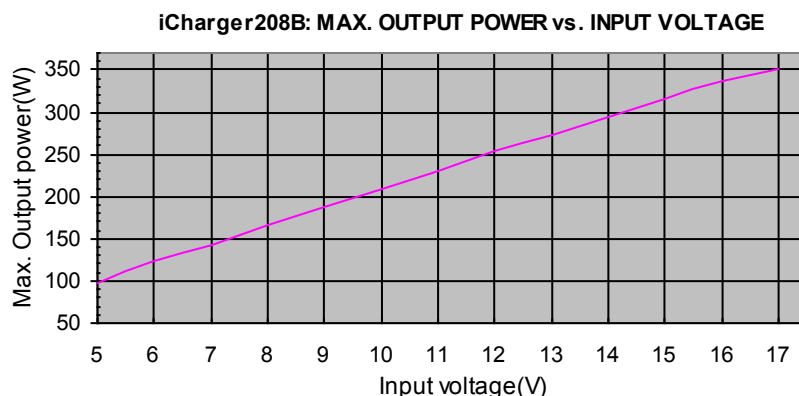

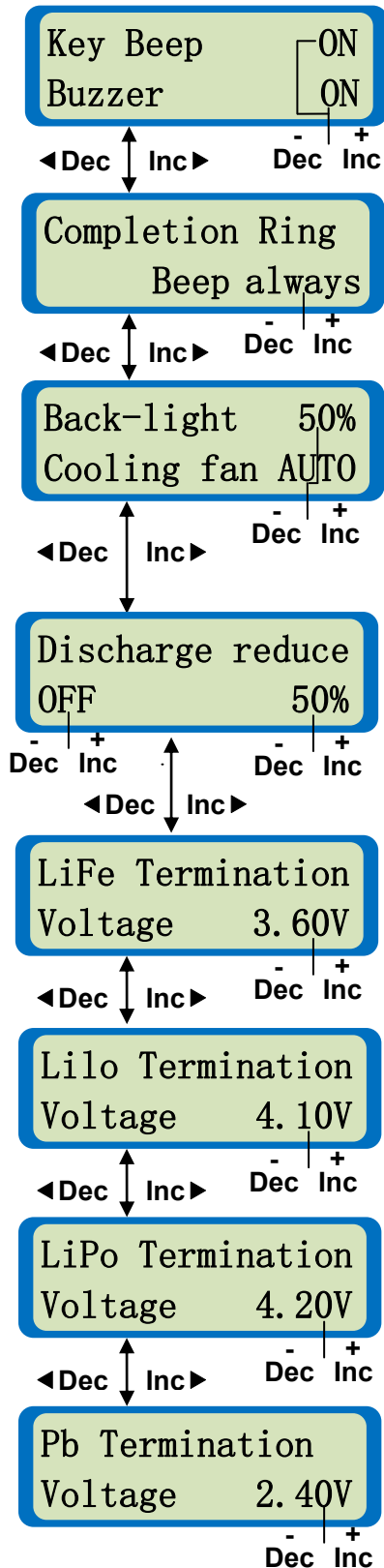

Key confirmation and alert tone. If the keyboard sound is ON there will be a beep when you press any key. If the buzzer is ON the iCharger will generate an alert tone for certain events.

Key Beep: OFF&ON: (ON, default)

Buzzer: OFF&ON: (ON, default)

Process completion tone. Controls the tones generated at end of charging or discharging and the cyclic charging/discharging indication.

Options: Beep 5 times, Beep 3 minutes, Beep always (continuous until user presses STOP), Beep OFF (Beep always, default)

Back-light and cooling fan control. Adjust the LCD backlight brightness.

There are three cooling fan modes: ON, OFF, AUTO. In AUTO-Mode, iCharger adjusts the fan automatically to control its internal temperature.

Cooling fan: OFF, ON & AUTO (AUTO, default)

Discharge reduce setting. When you set it to "ON", If the final voltage target storage voltage is reached, the buzzer will beep for three times, and the left of the second line display "D>>", and the charger enters into the high precision discharge process. The process won't stop until the current reaches xx% of the configured discharge current.

Reduce: ON, OFF Range: 1 – 99%

Termination voltage for LiFe. Adjust LiFe's charge termination voltage.

Press Start/Enter for more than 3 seconds to blink the "Voltage" value, then press ◀Dec and Inc▶ to adjust the termination voltage.

Range: 3.40V – 3.90V, Step: 0.01V (3.60V, default)

Termination voltage for Lilo. Adjust Lilo's charge termination voltage.

Press Start/Enter for more than 3 seconds to blink the "Voltage" value, then press ◀Dec and Inc▶ to adjust the termination voltage.

Range: 3.90V – 4.20V, Step: 0.01V (4.10V, default)

Termination voltage for LiPo. Adjust LiPo's charge termination voltage.

Press Start/Enter for more than 3 seconds to blink the "Voltage" value, then press ◀Dec and Inc▶ to adjust the termination voltage.

Range: 4.00V – 4.30V, Step: 0.01V (4.20V, default)

Termination voltage for Pb. Adjust Pb's charge termination voltage. Press

Start/Enter for more than 3 seconds to blink the "Voltage" value, then press ◀Dec and Inc▶ to adjust the termination voltage.

Range: 2.20V – 2.50V, Step: 0.01V (2.40V, default)

Note: The Termination voltage controls the transition from Constant Current (CC) to Constant Voltage (CV) charging for LiXx and Pb chemistries. It also defines the per-cell limit for cell overvoltage detection.

If you change the default termination voltage, the charge and discharge setting screen will note this difference by alternatively blinking battery's type and setting voltage value.



Lithium battery program

The **iCharger** provides a number of Lithium programs including Balance, Normal, Fast and Storage. Only the Balance mode requires the balance lead connected. However, the other modes will provide additional per-cell over-voltage protection if the balance lead is connected compared to running them without it, where they can only utilize the total pack voltage.

	Balance connector required	Balancer active	Charge termination condition
Balance – Normal	Yes	Yes	$I_{cv} = I_{cc}/10$ OR $V_{out} = (cell_count \times cell_max_voltage) + 0.2$
Balance – Fast	Yes	Yes	$I_{cv} = I_{cc}/5$ OR $V_{out} = (cell_count \times cell_max_voltage) + 0.2$
Balance – Slow	Yes	Yes	$I_{cv} = I_{cc}/40$ OR $V_{out} = (cell_count \times cell_max_voltage) + 0.2$
Charge	Optional	No	$I_{cv} = I_{cc}/10$ AND $V_{out} = cell_count \times cell_max_voltage$
Fast Charge	Optional	No	$I_{cv} = I_{cc}/5$ AND $V_{out} = cell_count \times cell_max_voltage$
Storage	Optional	No	$V_{out} = cell_count \times cell_storage_voltage$
Cycle - charge	Optional	No	$I_{cv} = I_{cc}/10$ AND $V_{out} = cell_count \times cell_max_voltage$
Cycle - discharge	Optional	No	$V_{out} = cell_count \times cell_discharge_voltage$

I_{cc} = configured charge current for the CC phase

I_{cv} = charge current during the CV phase

$cell_max_voltage$ = configured termination voltage for the selected chemistry (eg LiPo = 4.2V)

$cell_storage_voltage$ = configured per-cell storage voltage for the selected chemistry

$cell_discharge_voltage$ = configured per-cell storage voltage for the selected chemistry

I_{cv} = charge current during the CV phase

- Any time the battery's balance lead is connected the charger will monitor and display the cell voltages.
- The balancer is only active during a BALANCE charge (not during the CHARGE or FAST programs)
- The balance speed setting (Slow, Normal, Fast) controls the end-of-charging current threshold.
- The CHARGE and FAST modes are identical except for the charge-termination threshold which is 1/10 of the charge current setting for CHARGE and 1/5 of the charge current setting for FAST mode.
- While the CHARGE and FAST modes do not include any balancing action it is still safer to have the balance lead connected since then the charger will provide per-cell over-voltage protection as described below.
- In all kinds of charge cycle, if the balance lead is connected and if any cell exceeds the allowable per-cell peak voltage for the configured chemistry, the charge current will be reduced to ensure the voltage does not rise any further. This will slow the charging process and if the charge current falls to 1/10 of the charge current setting this will result in the charge cycle stopping altogether. Note that this is not the normal CC-to-CV transition which would usually occur when all cells approach the nominal peak voltage for the configured chemistry, but is a safety measure to respond to unbalanced cells in any mode or at any time during the charge process.



Charging Lithium battery in BALANCE mode

This function is for balancing the voltage of Lithium-polymer battery cells while charging. In the balance mode the battery balance lead must be connected to the balance port on the right side of the iCharger. The pinout of the balance port is shown in the diagram below. Charging in this mode is different from the normal CHARGE mode because the iCharger can monitor the voltage of individual cells and adjust the input current fed into each cell to normalize the voltage (for example: LiPo battery within 4.2V).

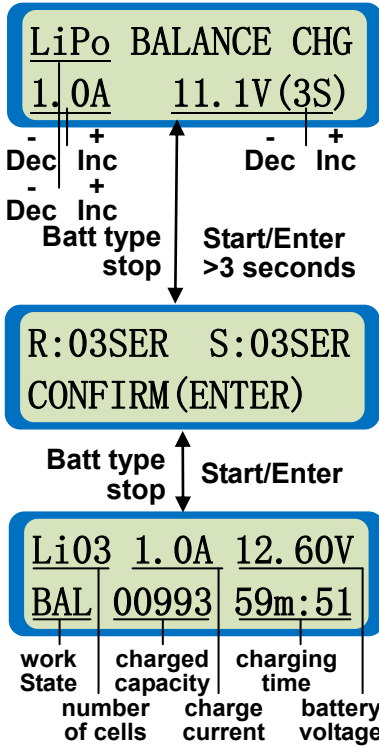

Balance charging mode of Lithium battery. The left side of the first line set the type of battery (LiPo, Lilo or LiFe). The value on the left side of second line sets the charge current and the value on the right side of second line sets the cell count and voltage of the battery pack. After setting the current and voltage, press **Start/Enter** for more than 3 seconds to start the next process.

Charge current: 0.05 – 20A, Voltage: 1 – 8 series

The number of cells you set and the processor detects. The left side of the first line 'R:xxSER' shows the number of cells detected by the iCharger and the right side of the first line 'S:xxSER' is the number of cells set by the user. Usually, the auto-detect number won't exceed the number set by the user. If the numbers are different you should make sure that the configured number and the actual number for the battery are the same and then you can start charging by pressing **Start/Enter**. If not, press **Batt type/Stop** to go back to the previous screen and adjust the setting.

Lithium BALANCE charging mode. The screen shows the status during the charging process. You can stop charging at any time by pressing **Batt type/Stop**. Press **Inc** to display each cell's voltage (see the balance voltage information) and press **Dec** to display the General Status Information.

Balance port and Individual Cell connection diagram

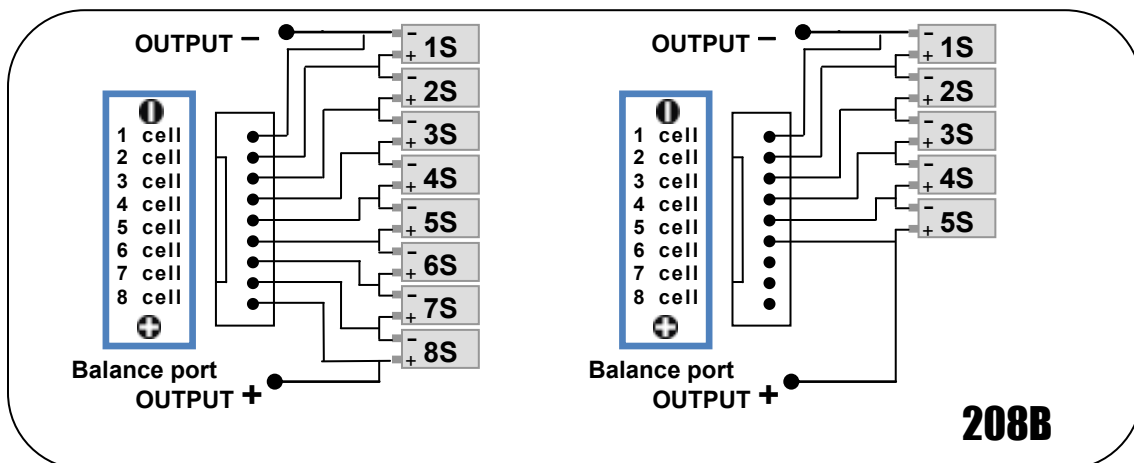



Charging a Lithium battery in normal CHARGE mode

The iCharger first charges with constant current (CC) according to the user setting then constant voltage (CV) when the charging voltage reaches the peak point. In the CV phase the current gradually falls. The iCharger will terminate charging when the current falls below than 1/10 of the configured charge current.

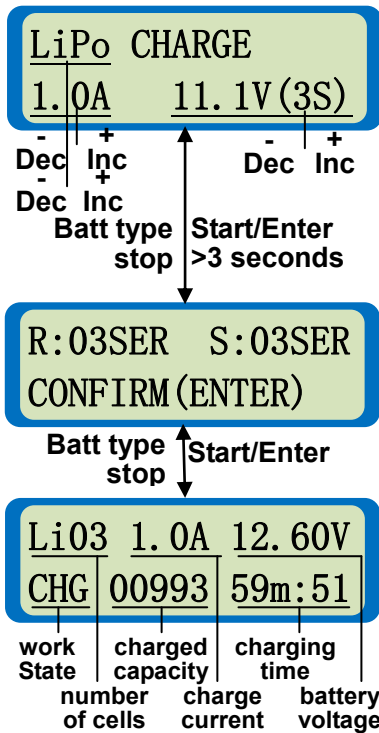

The left side of the first line set the type of battery (LiPo, Lilo or LiFe). The value on the left side of second line sets the charge current and the value on the right side of second line sets the cell count and voltage of the battery pack. After setting the current and voltage, press **Start/Enter** for more than 3 seconds to start the next process.

Charge current: 0.05 – 20A, Voltage: 1 – 8 series (LiFe to 10 series)

The number of cells you set and the processor detects. The left side of the first line 'R:xxSER' shows the number of cells detected by the iCharger and the right side of the first line 'S:xxSER' is the number of cells set by the user. Usually, the auto-detect number won't exceed the number set by the user. If the numbers are different you should make sure that the configured number and the actual number for the battery are the same and then you can start charging by pressing **Start/Enter**. If not, press **Batt type/Stop** to go back to the previous screen and adjust the setting.

Lithium CHARGE mode. The screen shows the status during the charging process. You can stop charging at any time by pressing **Batt type/Stop**. Press **Inc** to display each cell's voltage (see the balance voltage information) and press **Dec** to display the General Status information.

Fast charging a Lithium battery

The iCharger first charges with constant current (CC) according to the user setting then constant voltage (CV) when the charging voltage reaches the peak point. In the CV phase the current gradually falls. The iCharger will terminate charging when the current falls below than 1/5 of the configured charge current. This will result in slightly less than 100% charge but will complete sooner than the Normal charge mode.

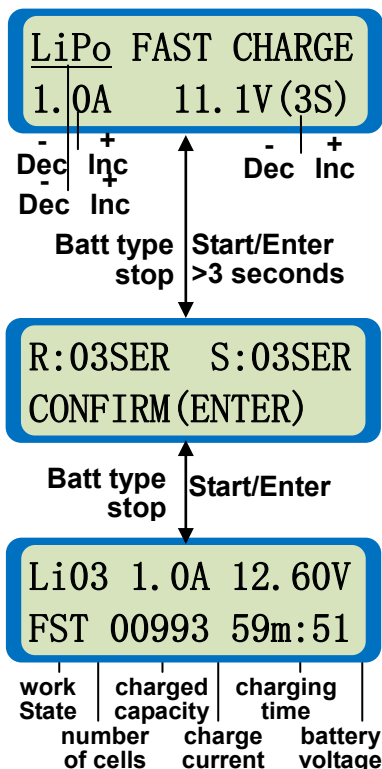

The fast charging mode of Lithium battery. The left side of the first line set the type of battery (LiPo, Lilo or LiFe). The value on the left side of second line sets the charge current and the value on the right side of second line sets the cell count and voltage of the battery pack. After setting the current and voltage, press **Start/Enter** for more than 3 seconds to start the next process.

Charge current: 0.05 – 20A, Voltage: 1 – 8 series (LiFe to 10 series)

The number of cells you set and the processor detects. The left side of the first line 'R:xxSER' shows the number of cells detected by the iCharger and the right side of the first line 'S:xxSER' is the number of cells set by the user. Usually, the auto-detect number won't exceed the number set by the user. If the numbers are different you should make sure that the configured number and the actual number for the battery are the same and then you can start charging by pressing **Start/Enter**. If not, press **Batt type/Stop** to go back to the previous screen and adjust the setting.

Lithium FAST charging mode. The screen shows the status during the charging process. You can stop charging at any time by pressing **Batt type/Stop**. Press **Inc** to display each cell's voltage (see the balance voltage information) and press **Dec** to display the General Status Information.



Pre-charging a Lithium battery

If the battery is over-discharged and the voltage is too low then in the Normal charge or Fast charge modes the iCharger will notify the user of pre-charging with a low current (100mA). This helps to increase the battery voltage to the within the allowable range for normal charging. The user can set the pre-charging time in the **Lithium Check time** screen in the **User setup**.

Pre-charging battery

The following screen is displayed when the charger detects the battery voltage to be too low in the Normal charge or Fast charge modes.

Do checking?
CONFIRM (ENTER)

Pre-charge lithium battery. Press **Start/Enter** to start the charging process or press **Stop** to go back to the previous screen.

Batt type stop ↑ Start/Enter ↓

Li03 0.1A 12.40V
CHK 00001 00m:51

Status display. The left side of the first line shows the type of battery (LiPo, Lilo or LiFe) and number of cells detected. In the middle is the pre-charge current (100mA). On the right is the voltage of the battery pack. The second line shows the charging progress with capacity charged (mAh) and charging time. The charger will switch back to the configured charge mode when the pre-charge time limit is reached. You can stop the pre-charging process at any time by pressing the **Batt type/Stop** button.

work state | charged capacity | charging time
battery of cells test pre-charge current | battery voltage online

“Storage” charge/discharge a Lithium battery

This mode is for charging/discharging a Lithium battery that is not to be used for an extended period. The program determines whether to charge or discharge the battery based on the configured target voltage and the measured initial voltage of the battery. The nominal target storage voltage depends on the type of Lithium battery: 3.75V/cell for Lilo, 3.85V/cell for LiPo and 3.3V/cell for LiFe. If at the start the battery voltage exceeds the target storage voltage the program will start to discharge rather than charge.

LiPo STORAGE
1.0A 11.1V(3S)

Storage of Lithium battery. The left side of the first line set the type of battery (LiPo, Lilo or LiFe). The value on the left side of second line sets the charge/discharge current and the value on the right side of second line sets the cell count and voltage of the battery pack. After setting the current and voltage, press **Start/Enter** for more than 3 seconds to start the next process.

Charge current: 0.05 – 20A, Voltage: 1 – 8series

Dec Inc ↑ Start/Enter >3 seconds ↓
Dec Inc

The number of cells you set and the processor detects. The left side of the first line 'R:xxSER' shows the number of cells detected by the iCharger and the right side of the first line 'S:xxSER' is the number of cells set by the user. If the numbers are different you should make sure that the configured number and the actual number for the battery are the same and then you can start charging by pressing **Start/Enter**. If not, press **Batt type/Stop** to go back to the previous screen and adjust the setting.

R:03SER S:03SER
CONFIRM (ENTER)

Batt type stop ↑ Start/Enter ↓

Li03 1.0A 12.60V
STO 00993 59m:51

Lithium STORAGE charging mode. The screen shows the status during the charging process. You can stop charging at any time by pressing **Batt type/Stop**. Press **Inc** to display each cell's voltage (see the balance voltage information) and press **Dec** to display the General Status information.

work state | charged capacity | charging time
number of cells | charge current | battery voltage



Discharging a Lithium battery

In this mode, you can set the target per-cell voltage and hence the final voltage (final voltage=cell voltage*number of cells). The lowest allowable cell voltage depends on the type of Lithium battery: 2.50V for Lilo, 3.00V for LiPo and 2.00V for LiFe per cell. If the battery is connected to the balance port, the **iCharger** can monitor the individual cell voltages. The discharge will stop immediately if any cell falls below the configured final voltage.

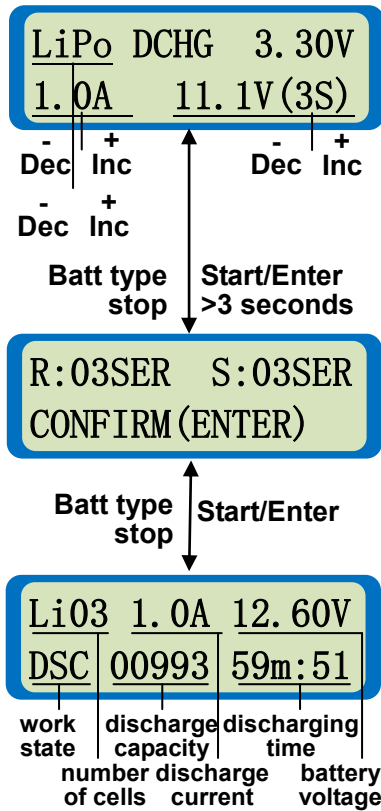

Discharge Lithium battery. The left side of the first line set the type of battery (LiPo, Lilo or LiFe) and the value on the right side shows the final discharge voltage of each cell. The value on the left side of second line sets the charge current and the value on the right side of second line sets the cell count and voltage of the battery pack. After setting the current and voltage, press **Start/Enter** for more than 3 seconds to start the next process.

Per-cell final voltage: LiPo (3.00 – 4.20V), Lilo (2.50 – 4.10V), LiFe (2.00 – 3.60V)
Discharge current: 0.05 – 20A , **Cell count:** 1 – 8S

The number of cells you set and the processor detects. The left side of the first line 'R:xxSER' shows the number of cells detected by the **iCharger** and the right side of the first line 'S:xxSER' is the number of cells set by the user. Usually, the auto-detect number won't lower than the number set by the user. If the numbers are different you should make sure that the configured number and the actual number for the battery are the same and then you can start charging by pressing **Start/Enter**. If not, press **Batt type/Stop** to go back to the previous screen and adjust the setting.

Discharge process. The **iCharger** allow its user to alter the discharging current during the process. Press **Start/Enter** to make the discharge current blink then press **Inc** to increase or press **Dec** to decrease the value and press **Start/Enter** to confirm the alteration. You can stop discharging at any time by pressing **Batt type/Stop**. Press **Inc** to display each cell's voltage (see the balance voltage information) and press **Dec** to display the General Status information.

Note: If you connect the balance port at the beginning of the discharging process, then the balance port will monitor each cell's voltage, if one of these cells' voltage reaches the termination voltage then the process will terminate with "balance port low cel vol". For example in LiPo mode, if one cell's voltage reaches 3.0V the process will stop.

If you want to avoid this "balance port low cell vol" message, then you can connect the balance port after the discharge process has started. In that case the process won't monitor each cell's voltage, just the pack's voltage and the discharge process will terminate when the pack voltage reaches the termination voltage (= target_cell_voltage x number_of_cells). For example in LiPo mode, the discharge process won't terminate until the pack's voltage reach N*3.0V.



Lithium battery external expanding discharge mode

You can expand the iCharger's discharge power capacity by connecting the external capacity resistance. What should pay special attention is that, when expanding discharge, the balance port must connect to the battery and the expanding capacity resistance R should be series connected to the positive pole (See in the following diagram)

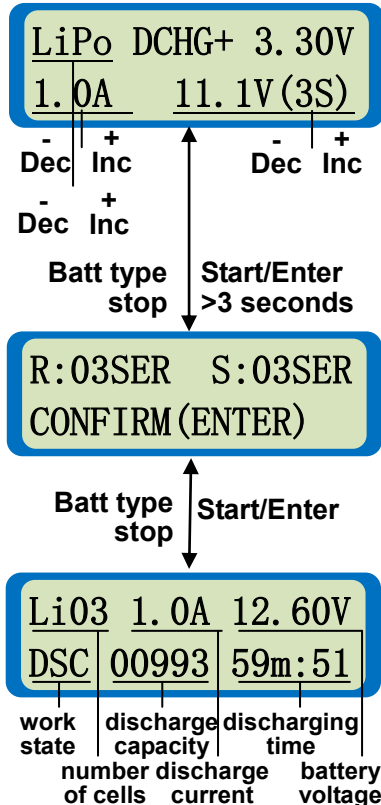
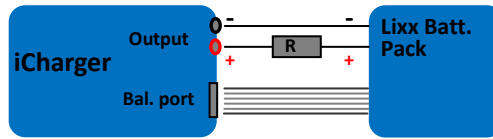

Discharge Lithium battery. The left side of the first line set the type of battery (LiPo, Lilo or LiFe) and the value on the right side shows the final discharge voltage of each cell. The value on the left side of second line sets the charge current and the value on the right side of second line sets the cell count and voltage of the battery pack. After setting the current and voltage, press **Start/Enter** for more than 3 seconds to start the next process.

Per-cell final voltage: LiPo (3.00 – 4.20V), Lilo (2.50 – 4.10V), LiFe (2.00 – 3.60V)
Discharge current: 0.05 – 20A, **Cell count:** 1 – 8S

The number of cells you set and the processor detects. The left side of the first line 'R:xxSER' shows the number of cells detected by the iCharger and the right side of the first line 'S:xxSER' is the number of cells set by the user. Usually, the auto-detect number won't lower than the number set by the user. If the numbers are different you should make sure that the configured number and the actual number for the battery are the same and then you can start charging by pressing **Start/Enter**. If not, press **Batt type/Stop** to go back to the previous screen and adjust the setting.

Discharge process. The iCharger allow its user to alter the discharging current during the process. Press **Start/Enter** to make the discharge current blink then press **Inc** to increase or press **Dec** to decrease the value and press **Start/Enter** to confirm the alteration. You can stop discharging at any time by pressing **Batt type/Stop**. Press **Inc** to display each cell's voltage (see the balance voltage information) and press **Dec** to display the General Status information.

In this mode, the lithium battery discharges through iCharger and R, $P = P_i + P_r$, (P_i is charger's wasted power capacity; P_r is wasted power capacity by resistance). P_i is limited by the set charger's maximum discharge power capacity (<30W). But in the first 30 seconds of discharge startup, P_i can be reached 150W. This characteristic is tend to active some resistance loads which shows a remarkably increase in resistance value along with increase of the temperature, such as bulbs.

External capacity resistance's setting:

$$R = V_{bat} / I_{set};$$

$$P = V_{bat} * I_{set};$$

R: The value of the external capacity resistance

P: Rating capacity of the external capacity resistance

For example: discharge a pack of 20V lithium battery at 7A

$$R = 20V / 7A = 2.85\Omega$$

$$P = 20V \times 7A = 140W$$



Charge-to-discharge & Discharge-to-charge cycle mode for a Lithium battery

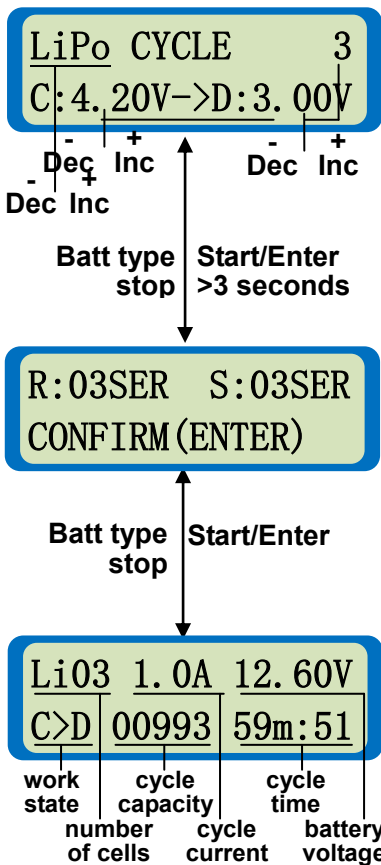

Charging/discharging cycle mode of Lithium battery.

The left side of the first line sets the type of battery (LiPo, Lilo or LiFe) and the right side shows the cycle number. The second line shows the cycle direction you selected: (C: x.xxV->D: x.xxV) or (D: x.xxV->C: x.xxV), the value of the second line sets the final charge/discharge current. After setting the current and voltage, press **Start/Enter** button for more than 3 seconds with a sound "Di" to start the next process.

Cycle number: 1 – 10

Voltage: LiPo (3.00 – 4.20V), Lilo (2.50 – 4.10V), LiFe (2.00 – 3.60V)

The number of cells you set and the processor detects. The left side of the first line 'R: xxSER' shows the number of cells detected by the **iCharger** and the right side of the first line 'S:xxSER' is the number of cells set by the user. If the numbers are different you should make sure that the configured number and the actual number for the battery are the same and then you can start charging by pressing **Start/Enter**. If not, press **Batt type/Stop** to go back to the previous screen and adjust the setting.

Charging/discharging cycle mode of Lithium battery.

In this process, you can stop the cycle at any time by pressing the **Batt type/Stop** button. In the process of C>D or D>C, the blink "C" indicates charging, while "D" indicates discharging. Press **Inc** button to display each cell's voltage and its past cycling current (see the balance voltage information & cycling information) and press **Dec** button to display the General Status information.

During the waiting time of discharge-to-charge cycle mode, you can stop the waiting process with pressing "Start" button for three seconds!

Lithium battery in monitoring mode

When you use other devices to charge or discharge Lithium pack, the **iCharger** can monitor each cell's voltage, battery temperature, charge time and so on, if one of the batteries appears over-charged, over-discharged, over-hot, over-capacity or over-time, the **iCharger** will alarm with noise "Di....." and blink the related information.

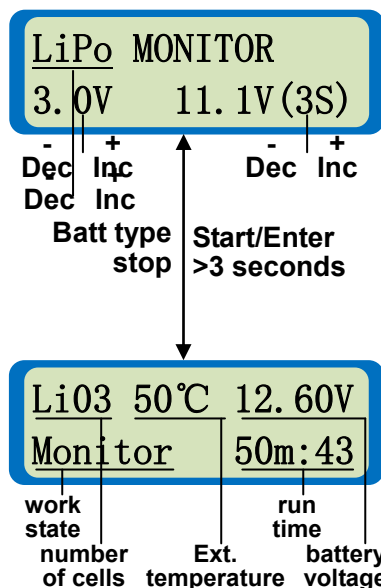

Monitor mode of Lithium battery. The left side of the first line sets the type of battery (LiPo, Lilo or LiFe). The value on the right side of the second line sets the low limit of voltage and the battery pack number. After setting the current and voltage press **Start/Enter** button for more than 3 seconds with a sound "Di" to start the next process.

Individual alarm low-Vt: final discharging voltage to the highest charging voltage (such as: LiPo 3.0V – 4.2V),
Battery series: 1 – 8 series

The monitor information, in this process; you can stop monitoring process at any time by pressing **Batt type/Stop** button.

Press **Inc** button to display each cell's voltage (see the balance voltage information), the **iCharger** will alarm with noise "Di...." when any errors appear.

Note: when in Li monitor Mode, no need connecting the main port if connecting the balance port.



NiCd/NiMH battery program

Charging a NiCd/NiMH battery

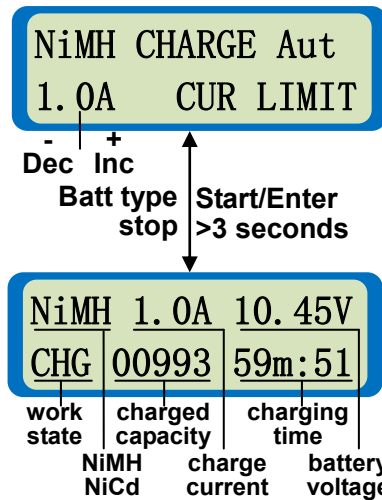

The left side of the first line displays the type of battery (NiCd/NiMH) and the second line allows you to set the current limit. The iCharger offers two charging modes for NiCd/NiMH., 'CHARGE Aut' and 'CHARGE Manual'. In 'Aut' mode the user sets the upper limit for the charging current. The iCharger will charge with about 1C automatically but no higher than the configured current. In 'Manual' mode it will charge at the configured current. Press **Start/Enter** for more than 3 seconds to start charging.

Current for Aut: 0.05 – 20A; Current for Manual: 0.05 – 20A

Charge status. You can stop the process at any time by pressing **Batt type/Stop**. Press **◀Dec** to display the General Status information.

Discharging a NiCd/NiMH battery

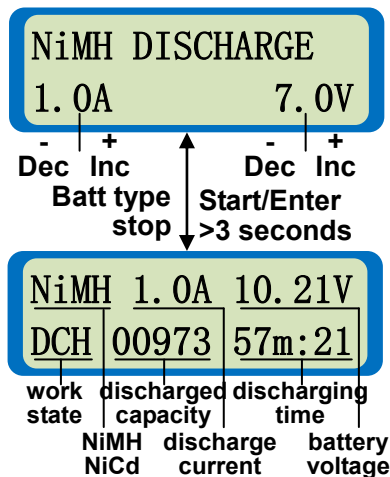

The left side of the first line shows the type of battery (NiCd/NiMH). The value in the second line sets the discharge current on the left and final voltage on the right. Press **Start/Enter** for more than 3 seconds to start discharging.

Discharge current: 0.05 – 20A
Final voltage: 0.1 – 40.0V

Discharge status. You can stop the process at any time by pressing **Batt type/Stop**. Press **◀Dec** to display the General Status information.

Charge-to-Discharge & Discharge-to-Charge cycle mode for a NiCd/NiMH battery

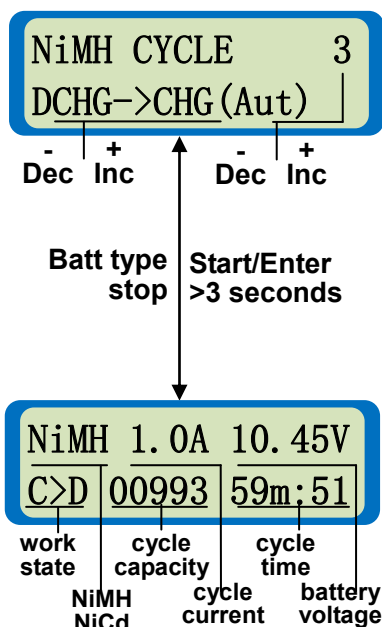

The left side of the first line shows the type of battery (NiCd/NiMH) and the right shows the cycle number. The second line shows the cycle direction you selected: (CHG (xxx) ->DCHG) or DCHG->CHG(xxx)). You can set the charge mode as "Charge Auto" or "Charge Manual". The discharge parameters are those set in NiCd/NiMH discharge screen. Press **Start/Enter** for more than 3 seconds to start the cycling.

Cycle number: 1 – 10
Cycle charge mode: 'Aut' or 'Man'

The screen displays the NiCd/NiMH cycle mode. On the left side of the second line, in the process is identified as either C>D or D>C. A blinking "C" indicates charging, while a blinking "D" indicates discharging.

You can stop the cycling process at any time by pressing **Batt type/Stop**. Press **Inc▶** to display the cycle history (see the balance voltage information & cyclic information) and press **◀Dec** to display the General Status information.

During the waiting time of discharge-to-charge cycle mode, you can stop the waiting process by pressing "Start" button for three seconds!



NiCd/NiMH forming charge

This forming charge program aims to eliminate capacity imbalance between cells in a battery.

The **iCharger** first charges with constant current (CC=1C) according to the user setting. When the charging voltage reaches the peak threshold (1.48V/cell) it switches to the CV phase. In the CV phase the current gradually falls. When the current drops to C/4 the **iCharger** will charge another 25% Capacity at C/10 current and then terminate the process.

NiMH Forming CHG			
1.0Ah	7.2V	(6S)	
-	+	-	+
Dec	Inc	Dec	Inc
Batt type stop		Start/Enter >3 seconds	

The left side of the first line shows the type of battery (NiCd/NiMH). The value on the left side of second line sets the cell capacity and the value on the right side of second line sets the cell count and nominal voltage of the battery pack. Press **Start/Enter** for more than 3 seconds.
Forming capacity: 0.1 – 9.9Ah
Cell count: 1 – 25S

NiMH	1.0A	10.45V
FRM	00993	59m:51
work state	forming capacity	forming time
NiMH NiCd	forming current	battery voltage

Forming status. You can stop the process at any time by pressing **Batt type/Stop**, and display the General Status information by pressing **Dec** button.
Note: In the first period (CV charging), it displays "CHG"/"FRM" alternately in Work State. It will display "FRM" when in the second period (CC charging).



Pb (lead-acid) battery program

This program is for charging Pb (lead-acid) batteries with nominal voltages from 2 to 36V. Lead-acid, VRLA or Gel batteries are totally different from NiCd or NiMH. They can only deliver relatively lower current compared to their capacity and charging can only be done at relatively low rates compared to other chemistries. The optimal charge current 01.C. Pb batteries must not be charged rapidly. Always follow the instructions supplied by the battery manufacturer.

Charging a Pb battery

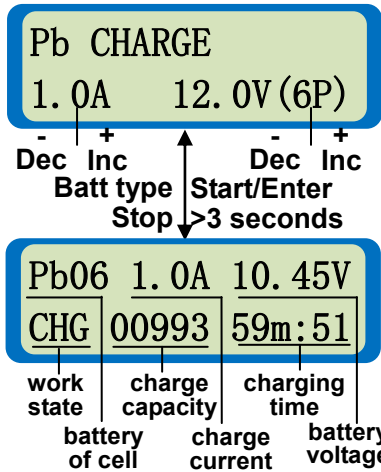

Charge Pb battery. The left side of the first line shows the type of battery(Pb). The second line shows the charge current and number of cells you selected. After setting the current and voltage press **Start/Enter** for more than 3 seconds to start the charging.

Charge current: 0.05 – 20A
Battery cells: 1 – 18P (2 – 36V)

Status display. You can stop the charging process at any time by pressing **Batt type/Stop**. Press **◀Dec** to display the General Status information.

Note: iCharger 208B can support Pb (lead-acid) foaming charge. First, you should start the setting of "Trickle" in "NiMH/NiCd/PbTrickle". It won't foam charge until the voltage is less than 2.25V/cell.

Discharging a Pb battery

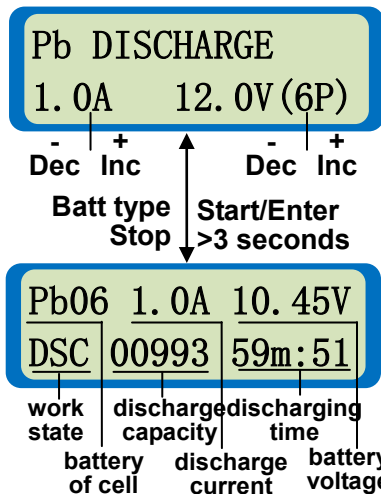

Discharging Pb battery. The left side of the first line shows the type of battery(Pb). The second line shows the charge current on the left and number of cells on the right. After setting the current and voltage press **Start/Enter** for more than 3 seconds to start the discharging.

Charge current: 0.05 – 20A
Battery cells: 1 – 18P (2 – 36V)

Status display. Press **Start/Enter** to adjust the discharge current And press **Inc▶** or **◀Dec** to increase or decrease the charge current. Store the new value by pressing **Start/Enter** again. You can stop the process at any time by pressing **Batt type/Stop**. Press **◀Dec** to display the General Status information.



Special modes program

Electric motor drive

You can easily break-in new **brushed** electric motors using a variable voltage and running time. **Note that the iCharger cannot directly drive brushless DC motors and that brushless motors do require or benefit from a breaking-in process.** With this function you also check the motor performance to optimize your power-train. The break-in process is essential for maximizing the power of a new brushed motor. New motors have square brushes which press up against the curved commutator. The goal for the break-in process is to gently shape the brushes so that they develop a curved surface that fits snugly against the commutator giving greater conducting surface area and hence lower losses and higher efficiency.

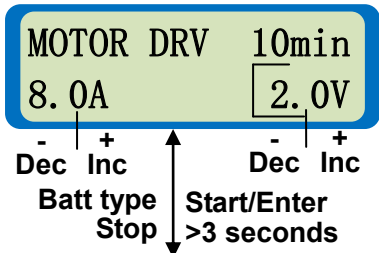

The value on the right side of the first line sets the test duration in minutes. The second line shows the upper limit of current on the left and drive voltage on the right. After setting the current and voltage press **Start/Enter** for more than 3 seconds to start the next process. A beep tone will sound.
Test time: 1 – 90 min, Current: 0.05 – 20A, Test voltage: 1 – 15V

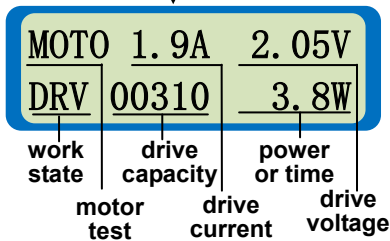

Status display. The top line shows the drive current and voltage. The second line shows the output capacity (mAh) and in the lower right corner alternately displays the output power or total run time. You can stop the test at any time by pressing **Batt type/Stop**.

Foam-Cut drive

In this mode, the charger acts as a convenient power supply for a hot wire foam cutter.

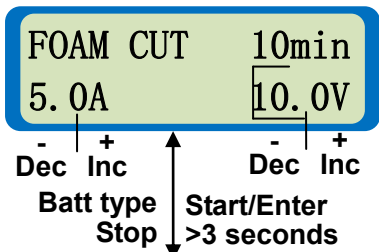

The value on the right side of the first line sets the run duration in minutes. The second line shows the upper limit of current on the left and foam cut voltage on the right. After setting the current and voltage press **Start/Enter** for more than 3 seconds to start the process. A beep tone will sound.
Runing time: 0– 90 min (0 refers to stopping the process by yourself)
Current: 0.05 – 20A, voltage: 1 – 40V

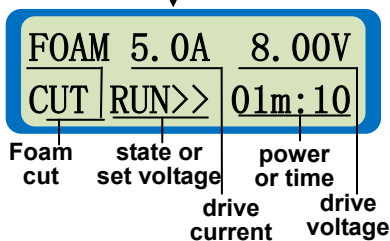

Status display. The top line shows the foam cut current and voltage. The second line shows the state and in the lower right corner alternately displays the output power or total run time. You can stop the test at any time by pressing **Batt type/Stop**.

Schematic Diagram

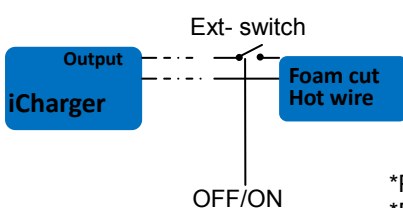

Work statement diagram

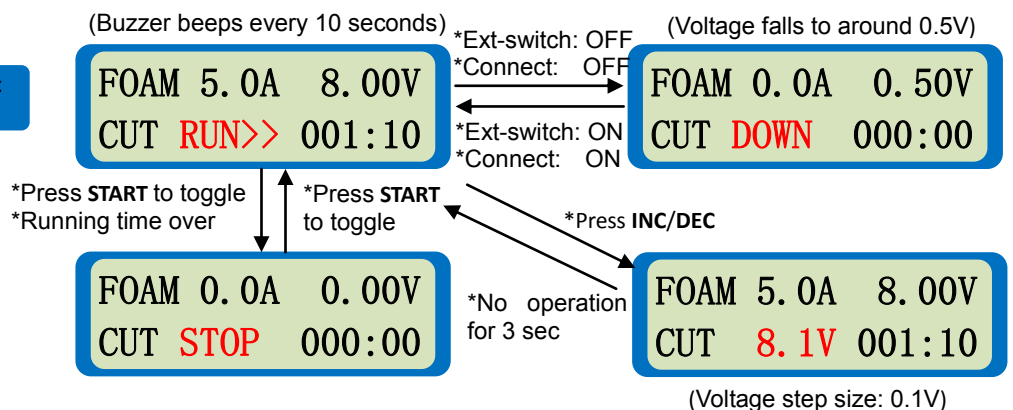



Measuring internal resistance of the battery

In general, the internal resistance of a battery is not a fixed value. It varies over time as the battery loses energy and also varies depending on the load, or how much current is drawn from the battery. One of the urgent requirements of a battery is low internal resistance. Measured in milliohms, the internal resistance is the gatekeeper that, to a large extent, determines the runtime. The lower the resistance, the less restriction the battery encounters in delivering the needed power spikes.

The iCharger can not only measure the internal resistance of the battery pack, and also can measure the per-cell internal resistance (only available for lithium battery) .

Measure Internal Resistance

Measure internal resistance. You can press **Start/Enter** for more than 3 seconds to start the process and stop at any time by pressing **Batt type/Stop**.

Batt type Stop >3 seconds

The two lines show the first to the sixth cell's internal resistance, which is only available for the lithium battery. Press **Inc▶** or **◀Dec** to display more information of the seventh to the tenth cell's internal resistance. Press **Start/Enter** to measure it again, and press **Batt type/Stop** to return to the main menu.

1: 21 24 19mΩ
4: 18 26 16mΩ

Inc▶
◀Dec

The two lines show the seventh to the tenth cell's internal resistance, which is only available for the lithium battery. Press **Inc▶** or **◀Dec** to display the General Status information. Press **Start/Enter** to measure it again, and press **Batt type/Stop** to return to the main menu.

7: 20 29

Inc▶
◀Dec

Status display. This screen displays the battery pack internal resistance. Press **Inc▶** or **◀Dec** to display the General Status information. Press **Start/Enter** to measure it again, and press **Batt type/Stop** to return to the main menu.

Battery Pack IR
173mΩ

Note: You can check the internal resistance by **Present testing information**; see detail information in Page 8.



Data save/load program

The iCharger has a storage and load program for your convenience. This feature can store up to 10 battery datasets by number. Each dataset represent your settings for a particular set of batteries. Datasets can be reloaded for charging or discharging to save having to re-enter all the parameter values again by hand.

Data save program

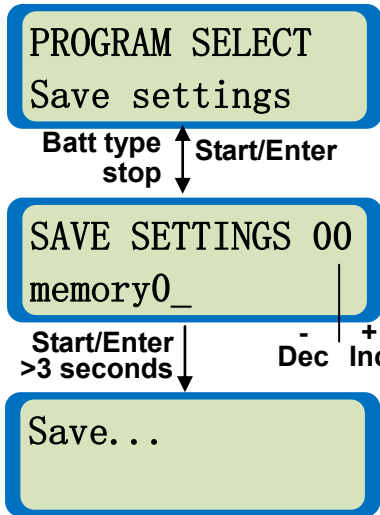

This screen displays the data save program. You can press **◀Dec & Start/Enter** button for 3 seconds to enter this interface directly.

In the first line, number “00” refers to the target memory number the user wants to choose. In the second line, the “memory0_” refers to the character the user wants to input. Press **Inc▶ / ◀Dec** button to walk letters, and then press **Start/Enter** button to confirm the chosen letter and moves to the next letter position, when you finish the character, press **Start/Enter** button twice to confirm the character. You can delete a wrong chosen letter by pressing **Batt type/Stop** button. Hold **Start/Enter** button for more than 3 seconds to save the currently displayed name. Hold **Batt type/Stop** button to exit without saving changes done.

Storage number: 00 – 09

Storing all of the current data into the specified memory location.

Data load program

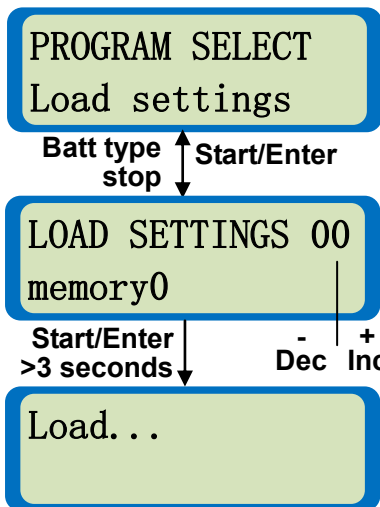

This screen displays the data load program. You can press **Inc▶ & Start/Enter** button for 3 seconds to enter this interface directly.

In the second line, “memory0” refers to the source memory number the user wants to choose. Press **Start/Enter** for more than 3 seconds to start the process.

Memory location number: 00 – 09

Load all parameters values from the selected location.

Note: As for the “LOAD SETTING” program. You can load in any of the numbers you have saved in the “SAVE SETTING” from “00-09”, for example, when you finish the last setting of

NiMH FORMING CHG
1.0Ah 7.2V (6S)

then you save it as 01 in the saving settings, and in the load setting, when you set “memory 01” and press “Start” button to load, and then the interface will display the

NiMH FORMING CHG
1.0Ah 7.2V (6S)

And use the current information directly.



Log Files Management

iCharger 208B has a 16Mbit flash storage, which can log offline charge and discharge data in 36 hours. The users can transfer these data to logview for analyzing and plotting when it is necessary.

PROGRAM SELECT
Log files 2016Kb

Log files management. The value showed on the left side of the second line is **Free Capacity / Free Logging Time** alternatively.

Batt type stop
Free Capacity & Free Time
Start/Enter

Manage the file. The first line shows "Select[X/Y] nnnnn" (X: the sequence number of the current selected file; Y: total number of the files; nnnnn: the log number included in files). The second line shows the selected file name.

Select[0/2]
Logs OFF

File Select: Press **Inc** or **Dec** to select.

Note: The number 0 means "Logs OFF", if you select this item, it will turn off Log File function.

Dec Inc

File Create: Hold **Inc** for more than 3 seconds, the user can set up at most 8 files.

File Transfer: Press **Start/Enter** for more than 3 seconds.

File Empty: Press **Dec** and **Inc** for more than 3 seconds.

File Delete: Press **Batt type/Stop** and **Dec** for more than 3 seconds.

Inc >3 seconds

File Create
LogFile3_

User-defined the files name. (Name setting method: Press **Inc** or **Dec** to choose the letter, press **Start/Enter** to confirm your selection and move to the next one, press **Batt type/Stop** to delete the character.) After input, press **Start/Enter** 2 times for confirmation, or press **Start/Enter** for more than 3 seconds with a sound "Di", **iCharger** takes in the user setting to set up the files.

Start/Enter >3 seconds

File Transfer...
00050/01000

iCharger transfers the logging data to **Logview** software via USB. The second line shows the two values are "have transferred logging number/ the total logging number". In the course of transferring, you can press **Batt type/Stop** to stop it.

Note: The connecting steps of the receiving the data operation into Logview is the same as **iCharger** charges and discharges. See details in "**Using logview for 208B**" (P29)

Batt type stop

Dec&Inc >3 seconds

File Empty?
CONFIRM (ENTER)

Press **Start/Enter** to empty the file, and press **Batt type/Stop** to cancel it.

Stop&Dec >3 seconds

File Delete?
CONFIRM (ENTER)

Press **Start/Enter** to delete the file, and press **Batt type/Stop** to cancel it.



General Status information

General Status Information

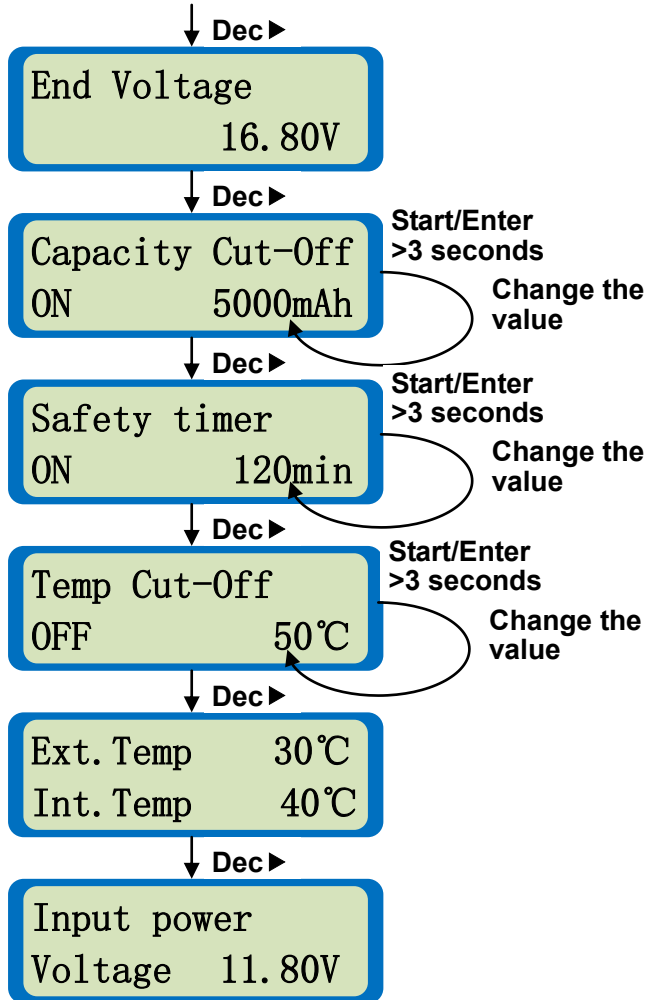

Voltage of Balance Port

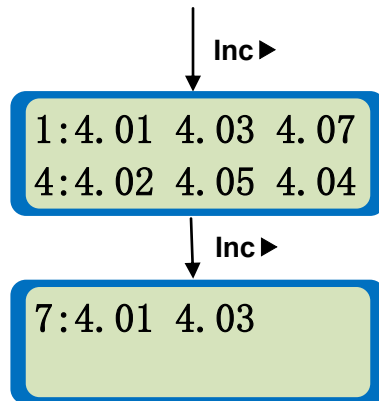

Cycle Information

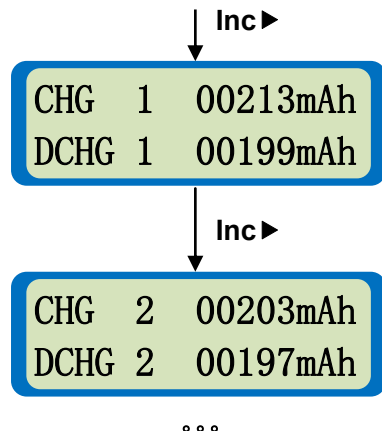

Note: Toggle back to the last viewed parameter via the ◀Dec button, press ◀Dec again to move to the next parameter.

Warning and error information

The iCharger incorporates a wide range of protection and alarm functions to monitor the operation of the charger. This includes verifying the internal state and the condition of its electronics. In the case of any error being detected the screen displays the error cause and the charger generates 3 beeps. If the error occurs during a charging, discharging or cycling process the error message and termination data will appear alternately.

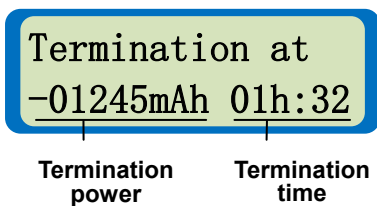

When an error has been reported press Batt type/Stop to return to the main menu. Press Inc▶ or ◀Dec to check the parameter value related to the error. For example in the case of a temperature error you can check the temperature that triggered the error. Press Start/Enter to return to the error message screen. Expression "-" refers to the discharged capacity to packs



Error messages

REVERSE POLARITY CHECK	The output is connected to a battery with incorrect polarity
CONNECTION BREAK DOWN	This will be displayed when an interruption of the connection between battery and the charger output has been detected during charging or discharging.
SHORT ERROR BREAK DOWN	A short-circuit at output. Please check the charging leads.
INPUT VOLTAGE LOW VOLTAGE	The input voltage is below the limit set in the USER SET menu.
INPUT VOLTAGE OVER VOLTAGE	The input voltage is over the limit (32V).
BALANCE PORT CELL LOW VOL	The voltage of one of the cells in the Lithium battery pack is too low. Please check the cell voltages one by one.
BALANCE PORT CELL HIGH VOL	The voltage of one of the cells in the Lithium battery pack is too high. Please check the cell voltages one by one.
BALANCE PORT NOT CONNECT	In Balance charge mode, no battery is connected to the charger's balance port.
BATTERY CHECK LOW VOLTAGE	Without using the balance port, the cell count detected by the charger is less than that set by the user. Please check the cell count of the battery pack.
BATTERY CHECK OVER VOLTAGE	Without using the balance port, the cell count detected by the charger is higher than that set by the user. Please check the cell count of the battery pack.
Int. TEMP OVER CHG STOPPED	The internal temperature is over 65°C(149 °F). Cool down the unit.
Ext. TEMP OVER CHG STOPPED	The external temperature sensor detects (battery) temperature above the limit.
CAPACITY OVER STOPPED	The capacity (mAh) charged or discharged reached the configured protection limit.
SAFETY TIME OUT STOPPED	The charge or discharge time reached the configured protection limit.



USB port installation

Install USB driver

This release of the USB driver is contained on the **iCharger 208B software CD-ROM**.

To install the USB driver, run the program **X:\USB driver\iChargerUSBInstaller.exe** (where **X** is the drive letter designator for your **CD-ROM** drive.)

Charger firmware upgrade steps

- Install the **iCharger** USB driver
- Run the program **X:\Upgrader\Upgrader.exe** (you can download the **Upgrader.exe** software from the following website: <http://www.jun-si.com/UploadFiles/Upgrader.rar>).
- Connect the **iCharger** to the PC using the supplied USB cable, choose “Device” in “Device List”, then select the upgrade file (you can download the latest file). The progress bar will appear after you click “Update...”

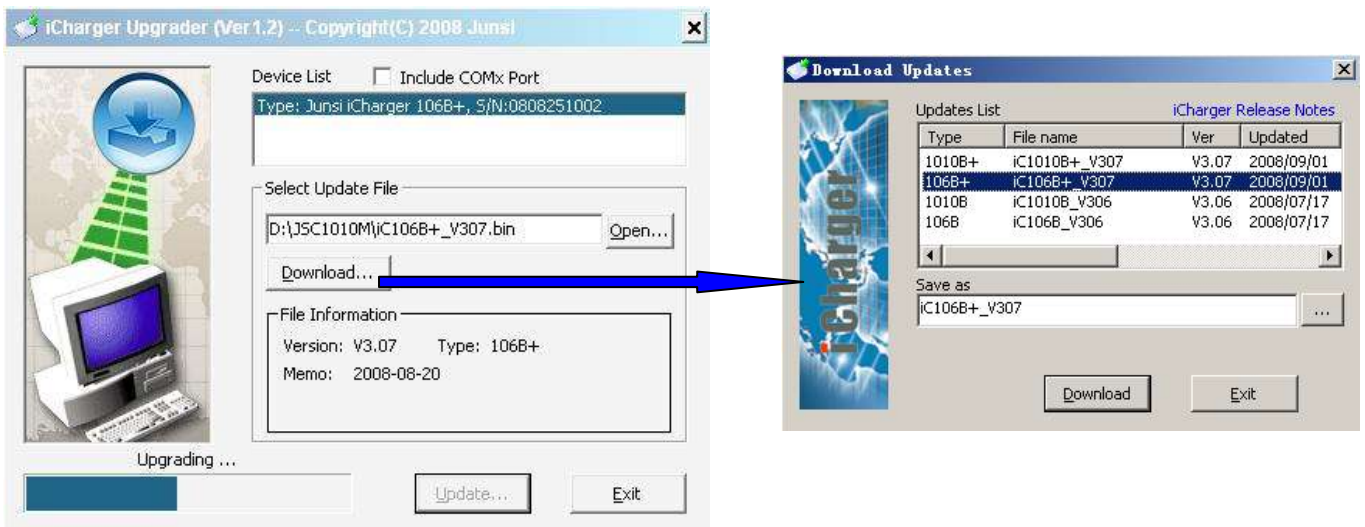

Note: You must only ever use the supplied USB cable provided with your iCharger as this is a custom cable with internal differences from other USB cables.



Using LogView for 208B

First, our sincere gratitude to the LogView development team: <http://www.logview.info>

Ensure you have installed the USB driver for the **iCharger**.

Communication steps:

- To install **LogView**, run the program **X:\logview \ LogViewInstaller.exe** (where **X** is the drive letter designator for you **CD-ROM** drive.)
- Connect the **iCharger** to the PC using the supplied USB cable
- Start **LogView** , then follow the illustrated instructions below:

1) Please choose language first, since the default language is German.

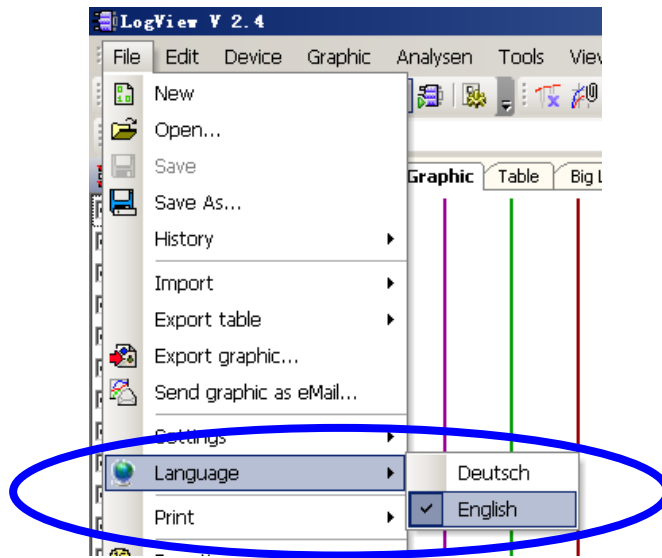

2) Click **Device**→**Choose device and port**.

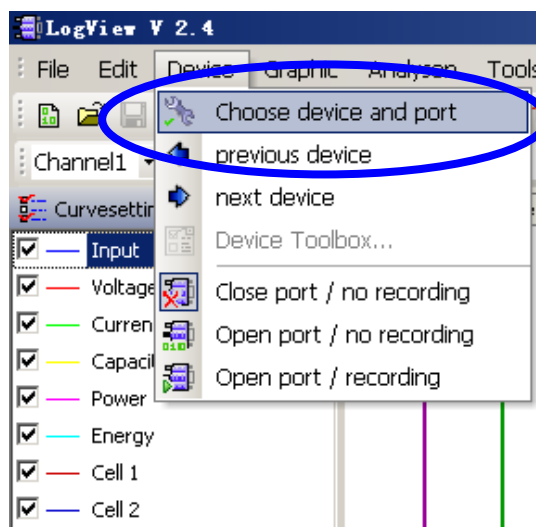



3) Choose iCharger 208B from the list and then choose the correct communication Port.

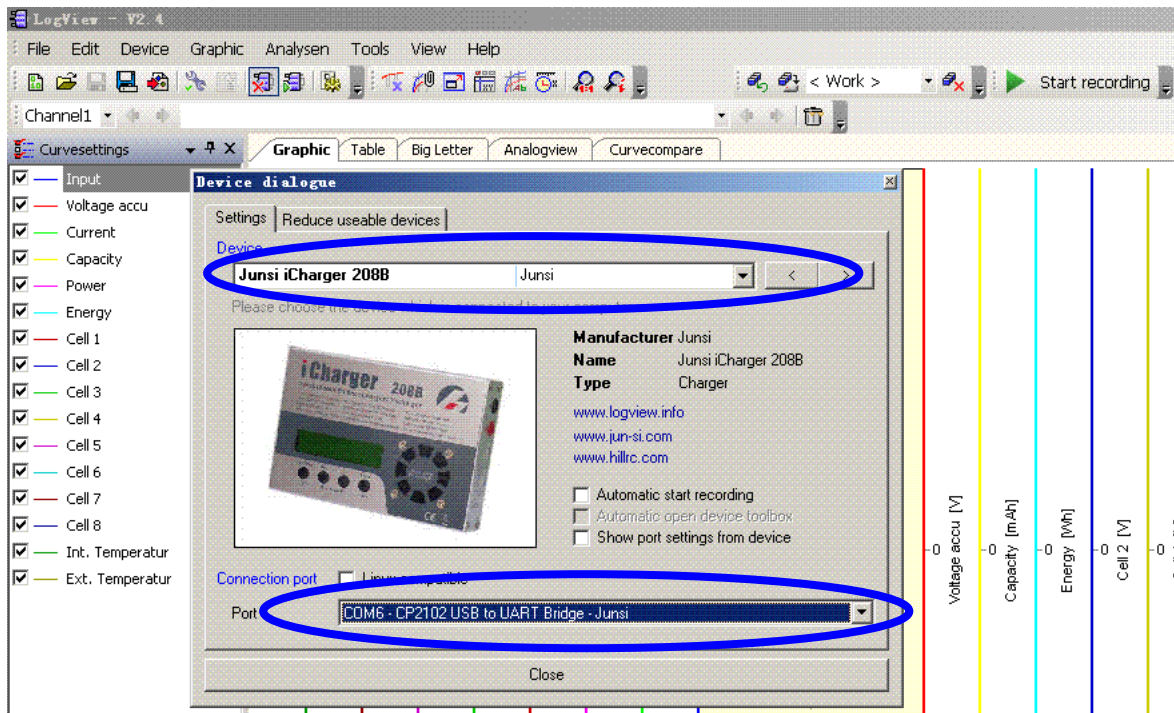

4) Start iCharger's charge or discharge mode, then click "Start recording" to record data.

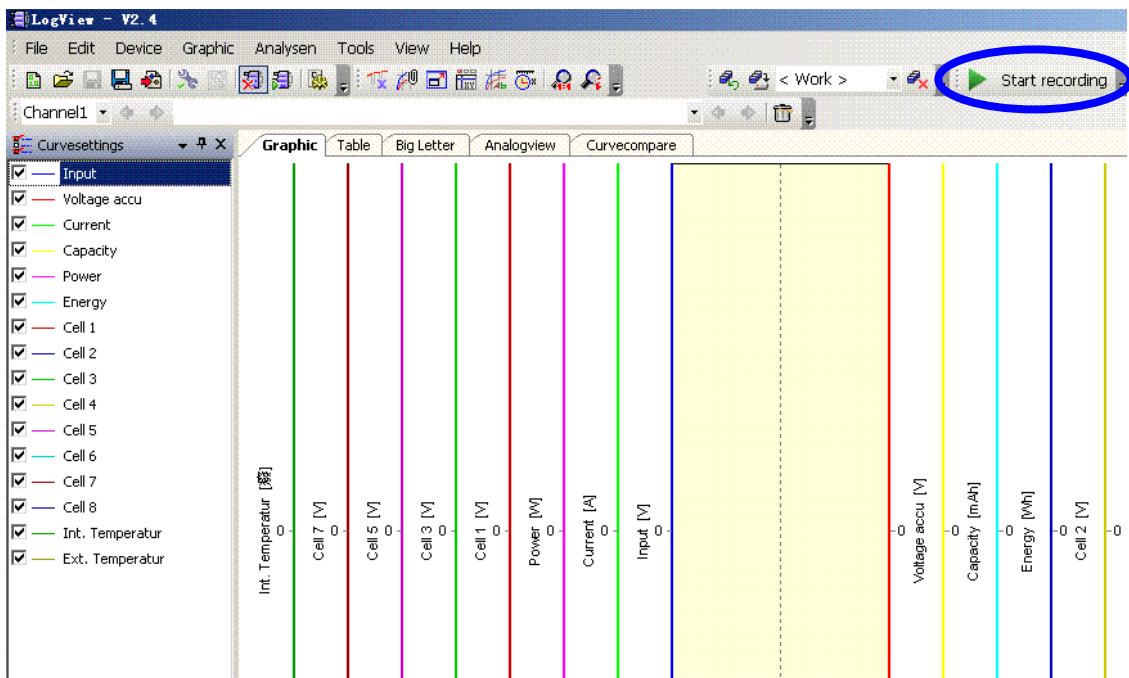



Refer to the **LogView** online help for more information about its features and operation.





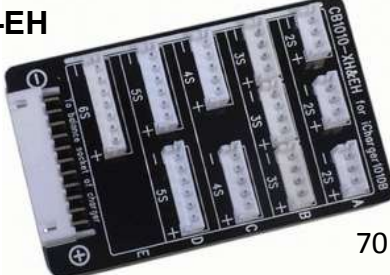

Optional parts

Balance Connector Conversion Board

<p>CB1010-XH</p>  <p>70 X 44mm</p>	<p>CB1010-EH</p>  <p>70 X 44mm</p>
<p>For Align/Dualshy pack etc.</p>	<p>For Kokam/Grauper pack etc.</p>
<p>CB1010-AQP</p>  <p>68 X 51mm</p>	<p>CB1010-TP</p>  <p>70 X 44mm</p>
<p>For Polyquest/Hyperion pack etc.</p>	<p>For Thunder power/Flight power packs etc.</p>

Wire

<p>BW-911</p>  <p>100mm</p>	<p>TW-2</p>  <p>300mm</p>
<p>Balance board connector 9—11</p>	<p>Temperature sensor with magnet</p>
<p>OW-JST</p>  <p>18AWG 300mm</p>	<p>OW-T</p>  <p>16AWG 300mm</p>
<p>4mm banana gold plug to JST output wire</p>	<p>4mm banana gold plug to T plug output wire</p>

Power supply

<p>P350</p>  <p>15V 23A 350W</p>	<p>Specifications:</p> <ul style="list-style-type: none"> ● Input Voltage Range: 100—240VAC ● Input Frequency: 50/60Hz ● Output Voltage: 14.9—15.5VDC ● Output Current: 0—23A ● Operating Temperature: -10—40°C ● Storage Temperature: -40—80°C ● Dimension(L X W X H) : 185 X 88 X 47mm ● Weight: 700g
--	--



Limited warranty

- **iCharger** are guaranteed to be free from defects in material and workmanship for a period of one calendar year from date of purchase. Your selling dealer is your first point of contact for warranty issues. Return postage costs are the responsibility of the user in all cases. Submit copy of original receipt with the return.
- Damage due to physical shock (dropping on the floor, etc), inappropriate power supply (automotive battery charger, etc), water, moisture, and humidity are specifically NOT covered by warranty. It is better checking your charger carefully before considering returning it as problems in setup, cabling, or power supply are much more common than defects in the charger. If there is damage stemming from these causes within the stated warranty period, the company will, at its option, repair or replace the charger for a service charge not greater than 50% of its then current retail list price.

Date of purchase/delivery:
Dealer:

Note: The manufacturer requires the user to be notified of any change or modification made to this device.

Enjoy the power!